

High Productivity Cooking Easyline Electric Boiling Pan with Auto Filling System 100lt

ITEM # _____

MODEL # _____

NAME # _____

SIS # _____

AIA # _____

232189 (EBE100AWF)

 Electric Boiling Pan, with
 auto filling system, 100lt

Short Form Specification

Item No.

Stainless steel construction with the deep drawn pan with rounded edges manufactured from AISI 304 stainless steel. Pan can be tilted beyond 90° to completely empty the food. Motorised tilting with tilting axis located in the middle of the pan to keep the pouring lip high and allow tall vessels to be filled. Automatic water filling of the steam generator.

Electric heating elements submerged directly in the water of the jacket. Food is uniformly heated via the base and the side walls of the pan by an indirect heating system using integrally generated saturated steam at a temperature of 112°C in a jacket with an automatic deaeration system. Safety valve avoids overpressure of the steam in the jacket. Safety thermostat protects against low water level. Max pressure at 0,5 bar.

High thermal input and fast heat up. Electromechanical control. Lower temperature outside the panels. IPX5 water protection. For freestanding installation one left column is necessary for each unit.

Main Features

- Food is uniformly heated in the base and side walls of the kettle by an indirect heating system that uses integrally generated saturated steam at a temperature of 108° C in the jacket with an automatic deaeration system.
- High thermal input and fast heat up.
- Automatic water filling of the double jacket.
- Ergonomic vessel dimensions, with a large diameter and shallow depth facilitates stirring and gentle food handling.
- Curved pan base guarantees that the appliance is also suitable to prepare small quantities of food.
- Safety thermostat protects against low water level.
- Safety valve avoids overpressure of the steam in the jacket.
- Compliant to CE requirements for safety.
- Constructed to meet the highest hygiene standards.
- Safe thanks to the higher water protection IPX5 and the lower temperature outside the panels.
- Fast working thanks to the high efficient heating technology and well insulation that keeps the heat inside the well.

Construction

- AISI 304 stainless steel construction, including deep drawn pan with rounded edges.
- Vessel can be tilted beyond 90° to completely empty the food.
- Motorised tilting.
- Electromechanical control.
- Ergonomic and user friendly thanks to the high tilting position and the pouring lip design which allow to easily fill containers.
- Tilting axis located in the middle of the pan keeps the pouring lip high and allow tall vessels to be filled.
- Electric heating elements are submerged directly in the water of the jacket, the heat losses are very low and the efficiency of the pan accordingly high.
- Max pressure at 0,5 bar, working pressure 0,4 bar.

Sustainability



- High-quality thermal insulation of the pan saves energy and keeps operating ambient temperature low.

Optional Accessories

- Left leg/column (to be ordered always one unit for single or multiple installation) PNC 928000
- Floor fastening kit (fastening is integrated in the floor - for a correct installation you need 1 for each pan plus 1 for the left column) PNC 928001
- Kit for a correct and easy positioning and installation of the pan (for a correct installation you need 1 for each pan) PNC 928002

APPROVAL: _____



Electrolux
PROFESSIONAL

High Productivity Cooking Easyline Electric Boiling Pan with Auto Filling System 100lt

- Floor fastening kit (fastening on the floor surface) PNC 928003
- Measure stick 100lt PNC 928008
- Strainer 8mm holes 100lt PNC 928012
- Bottom grid 100lt PNC 928016
- Basket 100lt, 3 required per pan PNC 928020
- Lifting hook, 2 required PNC 928021



High Productivity Cooking
Easyline Electric Boiling Pan with Auto Filling System 100lt

The company reserves the right to make modifications to the products without prior notice. All information correct at time of printing.

2024.12.20

Front

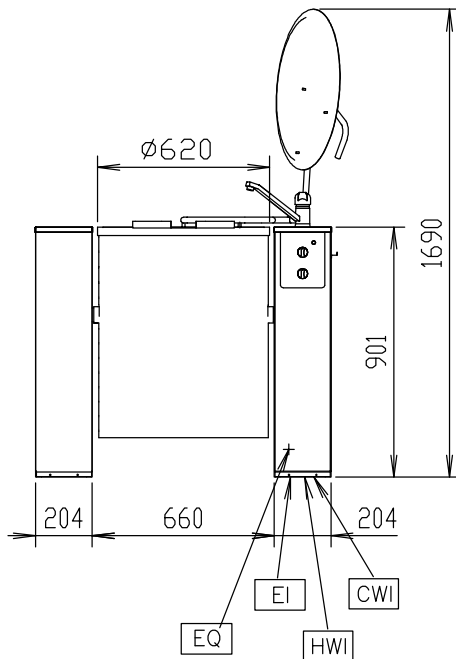

Side

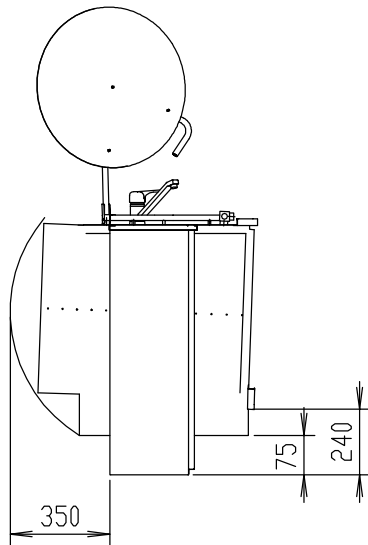

CWI = Cold Water inlet 1 (cleaning) HWI = Hot water inlet
 D = Drain
 EI = Electrical inlet (power)

Top

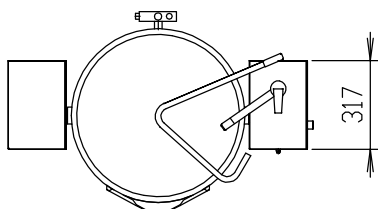

Electric

Supply voltage:

232189 (EBE100AWF)

400 V/3N ph/50-60 Hz

Electrical power max.:

15 kW

Key Information:

Working Temperature MIN: 30 °C

Working Temperature MAX: 108 °C

External dimensions, Depth: 780 mm

External dimensions, Height: 900 mm

Net vessel useful capacity: 100 lt

Tilting mechanism: Automatic

Bearing: Central